

Varenummer: 40550200312425  
 Beskrivelse: Tandhjulsgeær S201F-3,1-P71B5

## Mål

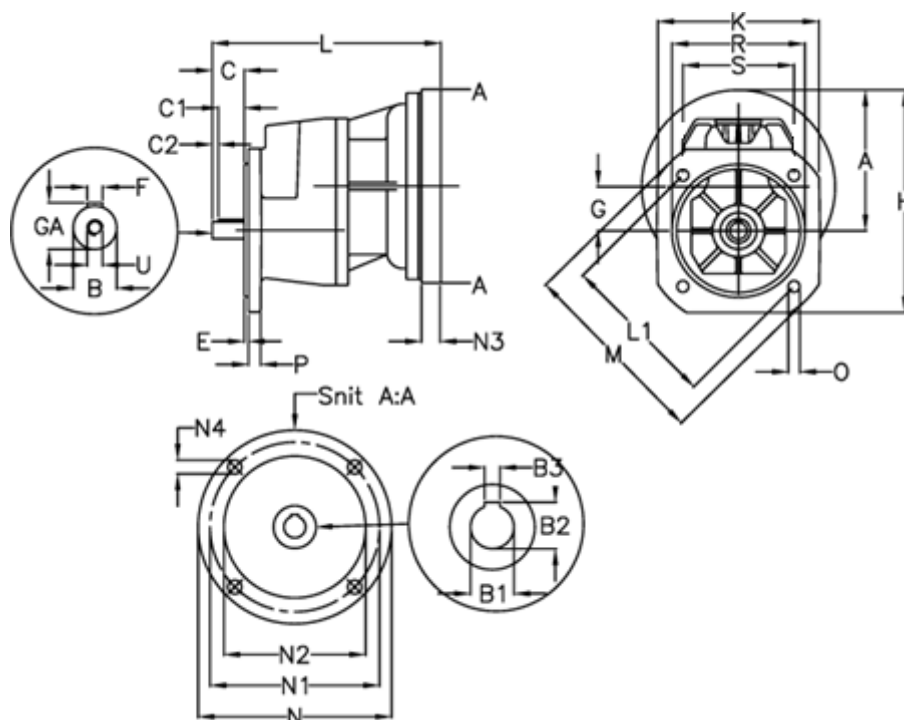

A = 109.5	E = 3.5	M = 200.0	R = 130
B = 19	F = 6x6x30	N = 160	S = 110
B1 = 14	G = 43.5	N1 = 130	U = M6
B2 = 16.3	GA = 21.5	N2 = 110	
B3 = 5	H = 184.5	N3 = -	
C = 40	K = 150	N4 = M8x16	
C1 = 30	L = 207	O = 11.5	
C2 = 5	L1 = 165.0	P = 10	